



DEPARTMENT OF REGULATORY AND ECONOMIC RESOURCES (RER)
BOARD AND CODE ADMINISTRATION DIVISION

MIAMI-DADE COUNTY
PRODUCT CONTROL SECTION
11805 SW 26 Street, Room 208
Miami, Florida 33175-2474
T (786) 315-2590 F (786) 315-2599

www.miamidade.gov/economy

NOTICE OF ACCEPTANCE (NOA)

Green-Span Profiles, L.P.
21200 FM 362
Waller, TX 77484

SCOPE:

This NOA is being issued under the applicable rules and regulations governing the use of construction materials. The documentation submitted has been reviewed and accepted by Miami-Dade County RER- Product Control Section to be used in Miami Dade County and other areas where allowed by the Authority Having Jurisdiction (AHJ).

This NOA shall not be valid after the expiration date stated below. The Miami-Dade County Product Control Section (In Miami Dade County) and/or the AHJ (in areas other than Miami Dade County) reserve the right to have this product or material tested for quality assurance purposes. If this product or material fails to perform in the accepted manner, the manufacturer will incur the expense of such testing and the AHJ may immediately revoke, modify, or suspend the use of such product or material within their jurisdiction. RER reserves the right to revoke this acceptance if it is determined by Miami-Dade County Product Control Section that this product or material fails to meet the requirements of the applicable building code.

This product is approved as described herein and has been designed to comply with the High Velocity Hurricane Zone of the Florida Building Code.

DESCRIPTION: "IWP Series" Insulated Steel Wall Panel

APPROVAL DOCUMENT: Drawing No. 438-0086T-13, titled "IWP Series", sheets 1 through 14 of 14, prepared by Brian N. Jaks, P.E., dated November 18, 2020, signed and sealed by Brian N. Jaks, P.E., on November 19, 2020, bearing the Miami-Dade County Product Control Revision stamp with the Notice of Acceptance number and the expiration date by the Miami-Dade County Product Control Section.

MISSILE IMPACT RATING: Large and Small Missile Impact Resistant

LABELING: Each panel shall bear a permanent label with the manufacturer's name or logo, city, state and the following statement: "Miami-Dade County Product Control Approved", unless otherwise noted herein.

RENEWAL of this NOA shall be considered after a renewal application has been filed and there has been no change in the applicable building code negatively affecting the performance of this product.

TERMINATION of this NOA will occur after the expiration date or if there has been a revision or change in the materials, use, and/or manufacture of the product or process. Misuse of this NOA as an endorsement of any product, for sales, advertising or any other purposes shall automatically terminate this NOA. Failure to comply with any section of this NOA shall be cause for termination and removal of NOA.

ADVERTISEMENT: The NOA number preceded by the words Miami-Dade County, Florida, and followed by the expiration date may be displayed in advertising literature. If any portion of the NOA is displayed, then it shall be done in its entirety.

INSPECTION: A copy of this entire NOA shall be provided to the user by the manufacturer or its distributors and shall be available for inspection at the job site at the request of the Building Official.

This NOA **revises & renews** NOA #19-0417.03 and consists of this page 1, evidence submitted pages E-1 and E-2 as well as approval document mentioned above.

The submitted documentation was reviewed by **Helmy A. Makar, P.E., M.S.**



Helmy A. Makar
02/04/2021

NOA No. 20-1202.02
Expiration Date: 01/14/2026
Approval Date: 02/04/2021
Page 1

Green-Span Profiles, L.P.

NOTICE OF ACCEPTANCE: EVIDENCE SUBMITTED

1. EVIDENCE SUBMITTED UNDER PREVIOUS APPROVAL # 15-0204.02

A. DRAWINGS

1. *Drawing No. 438-0086T-13, titled "IWP Series", sheets 1 through 14 of 14, prepared by Brian N. Jaks, P.E., dated May 29, 2015, signed and sealed by Brian N. Jaks, P.E., on June 10, 2015.*

B. TESTS

1. *Test report on Large Missile Impact Test per TAS 201, Cyclic Wind Pressure Test per TAS 203, and Uniform Static Air Pressure Test per TAS 202 on Exterior Steel Insulated Wall Panel, prepared by Force Engineering & Testing, Inc., Report No. 438-0086T-13, dated 12/09/2013, signed by Brandon Jasek, P.E.*
2. *Test report on Large Missile Impact Test per TAS 201, Cyclic Wind Pressure Test per TAS 203, on Exterior Steel Insulated Wall Panel, prepared by Force Engineering & Testing, Inc., Report No. 438-0239T-15, dated 10/12/2015, signed by Brandon Jasek, P.E.*

C. CALCULATIONS

1. *Calculations, 10 pages, prepared by Brian N. Jaks, P.E., dated October 13, 2014, signed and sealed by Brian N. Jaks, P.E., on October 13, 2014.*

D. QUALITY ASSURANCE

1. *By Miami-Dade County Department of Regulatory and Economic Resources.*

E. MATERIAL CERTIFICATIONS

1. *Tensile Test Data issued by Metallurgical Engineering Services, Inc., for **Interior Skin**, dated October 27, 2015, with mechanical properties of Sheet Steel.*
2. *Tensile Test Data issued by Metallurgical Engineering Services, Inc., for **Exterior Skin**, dated October 27, 2015, with mechanical properties of Sheet Steel.*
3. *Accelerated Weathering 2000 hours per ASTM D 659, Humidity test 1000 hours per ASTM D 1654, Salt Spray test per ASTM D 1654.*

2. EVIDENCE SUBMITTED UNDER PREVIOUS APPROVAL # 19-0417.03

A. DRAWINGS

1. *Drawing No. 438-0086T-13, titled "IWP Series", sheets 1 through 14 of 14, prepared by Brian N. Jaks, P.E., dated April 11, 2019, signed and sealed by Brian N. Jaks, P.E., on April 12, 2019.*

B. TESTS

1. *None.*



Helmy A. Makar, P.E., M.S.
Product Control Section Supervisor
NOA No. 20-1202.02
Expiration Date: 01/14/2026
Approval Date: 02/04/2021

Green-Span Profiles, L.P.

NOTICE OF ACCEPTANCE: EVIDENCE SUBMITTED

C. CALCULATIONS

1. *None.*

D. QUALITY ASSURANCE

1. *By Miami-Dade County Department of Regulatory and Economic Resources.*

E. MATERIAL CERTIFICATIONS

1. *None.*

3. NEW EVIDENCE SUBMITTED

A. DRAWINGS

1. *Drawing No. 438-0086T-13, titled "IWP Series", sheets 1 through 14 of 14, prepared by Brian N. Jaks, P.E., dated November 18, 2020, signed and sealed by Brian N. Jaks, P.E., on November 19, 2020.*

B. TESTS

1. *None.*

C. CALCULATIONS

1. *None.*

D. QUALITY ASSURANCE

1. *By Miami-Dade County Department of Regulatory and Economic Resources.*

E. MATERIAL CERTIFICATIONS

1. *None.*

F. STATEMENTS

1. *Florida Building Code, 2020 Edition compliance letter prepared by Brian N. Jaks, P.E., dated November 18, 2020, signed and sealed by Brian N. Jaks, P.E., on November 19, 2020.*



Helmy A. Makar, P.E., M.S.
Product Control Section Supervisor
NOA No. 20-1202.02
Expiration Date: 01/14/2026
Approval Date: 02/04/2021

Approval Document for Miami-Dade Notice of Acceptance

Applicant: Green-Span Profiles, LP
Category: Panels
Subcategory: Wall
Material: Composite
Description: IWP Series (Insulated Wall Panels)
Interior/Exterior Material: Steel
Core Material: Polyisocyanurate Foam

PRODUCT REVISED
as complying with the Florida
Building Code
Acceptance No. 20-1207.02
Expiration Date 01/14/2026
By [Signature]
Miami Dade Product Control

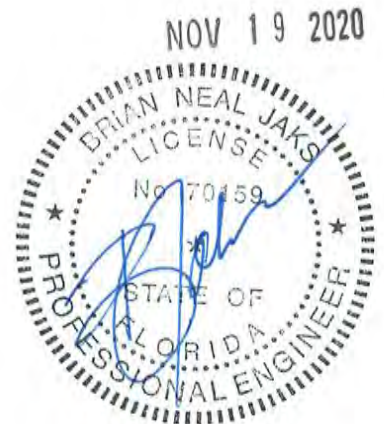

1. Compliance Statement – The product as described in this document demonstrated compliance with the Florida Building Code 2020, HVHZ.
2. Product Description – Wall panel system with an interior and exterior steel facing bonded to an insulating polyisocyanurate foam core. A concealed clip in the interlocking side-joint attaches the wall panels to supports. Structural application.
3. Panel: Green Span's IWP Series
 - 3.1. Profiles
 - 3.1.1. MesaLine
 - 3.1.2. VeeLine
 - 3.1.3. ShadowLine
 - 3.1.4. WaveLine
 - 3.1.5. Impression
 - 3.1.6. Stucco
 - 3.1.7. Infinity
 - 3.2. Thicknesses
 - 3.2.1. 2"
 - 3.2.2. 2.5"
 - 3.2.3. 3"
 - 3.2.4. 4"
 - 3.2.5. 5"
 - 3.2.6. 6"
 - 3.3. Widths: 42" maximum
 - 3.4. Side-joint: Green-Lock, interlocking double tongue-and-groove joint
 - 3.5. Materials
 - 3.5.1. Metal Facings
 - 3.5.1.1. Steel, ASTM A792 Galvalume coated or ASTM A653 G90 galvanized
 - 3.5.1.2. 50-ksi min. yield
 - 3.5.1.3. 26-ga. min
 - 3.5.1.4. Embossed or smooth finish
 - 3.5.2. Core
 - 3.5.2.1. Polyisocyanurate (PIR) insulating foam
 - 3.5.2.2. Huntsman Rubitherm WR 40618 / Rubinate 1850
 - 3.5.2.3. Non-ozone depleting blowing agent
 - 3.5.2.4. Nominal 2.25-pcf apparent density
 - 3.5.3. Concealed Clip
 - 3.5.3.1. Corrosion resistant G90 galvanized steel
 - 3.5.3.2. 14 gauge thickness
 - 3.5.3.3. 1 7/16" x 4" with (5) pre-punched holes
 - 3.5.4. Clip Fastener
 - 3.5.4.1. (2) ¼-14 self-driller, corrosion resistant
 - 3.5.5. Panel Fastener
 - 3.5.5.1. (3) 10-12 Fab-Lok

PRODUCT REVISED
 as complying with the Florida
 Building Code
 Acceptance No. 20-1202.02
 Expiration Date 01/14/2026
 By Heidi A. Weber
 Miami Dade Product Control



4. Substrate:
 - 4.1. 14-ga. minimum thickness
 - 4.2. Spaced at maximum 5'-0" on center

5. Performance
 - 5.1. TAS 201
 - 5.1.1. Large Missile Impact
 - 5.1.2. Passed
 - 5.2. TAS 203
 - 5.2.1. Cyclic Wind Pressure
 - 5.2.2. Passed
 - 5.3. TAS 202
 - 5.3.1. Design Wind Load
 - 5.3.1.1. Positive: +75-psf
 - 5.3.1.2. Negative: -75-psf
 - 5.3.2. Air Infiltration – passed
 - 5.3.3. Water Infiltration – passed
 - 5.4. ASTM E-84
 - 5.4.1. Flame Spread < 25
 - 5.4.2. Passed
 - 5.4.3. Smoke Developed < 450
 - 5.4.4. Passed
 - 5.5. ASTM D 3361
 - 5.5.1. Accelerated Weathering for 2000 hours
 - 5.5.2. Passed
 - 5.6. ASTM B 117
 - 5.6.1. Salt Spray for 1000 hours
 - 5.6.2. Passed

6. Identification: Each panel shall bear a permanent label with the manufacturer's name or logo, city, state and the following statement: "Miami-Dade County Product Control Approved."

7. Installation: per manufacturer's instructions and in compliance with attached drawings

8. Limitations of Use
 - 8.1. Panel supports shall be 14-ga. minimum thickness
 - 8.2. Supports shall be spaced at maximum 5'-0" on center
 - 8.3. Minimum (2) fasteners per clip
 - 8.4. Minimum (3) Fabloks installed at 10.5" on center along the interior panel face
 - 8.5. Panels shall not be used as axial or shear components.

PRODUCT REVISED
 as complying with the Florida
 Building Code
 Acceptance No. 20-1202.02
 Expiration Date 01/14/2026
 By Hedy A. Mahon
 Miami Dade Product Control



9. Approved Quality Assurance Entity – Factory Mutual

10. Reference Documents

- 10.1. Force Engineering & Testing Report No. 438-0086T-13, dated 12-9-2013
 - 10.1.1. TAS 201
 - 10.1.2. TAS 202
 - 10.1.3. TAS 203
- 10.2. Factory Mutual Approvals, Project ID: 3044381, dated 11-21-2012
 - 10.2.1. ASTM E84

PRODUCT REVISED
As complying with the Florida
Building Code
Acceptance No. 20-1202.02
Expiration Date 01/14/2026
By: *Heg A. N. Jaks*
Min:





DIM 'A' = 2", 2.5", 3", 4", 5", or 6"

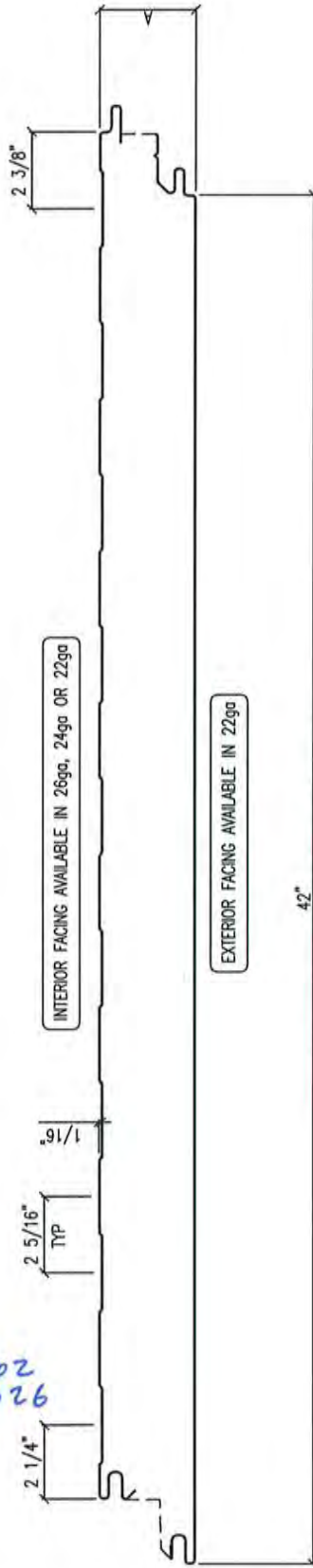

INTERIOR FACING AVAILABLE IN 26ga, 24ga OR 22ga

EXTERIOR FACING AVAILABLE IN 22ga

(ALSO AVAILABLE IN 36", 30" AND 24" WIDTHS)

EXTERIOR FACING HAS A HEAVILY EMBOSSED TEXTURE

PRODUCT REVISED
 as complying with the Florida
 Building Code
 Acceptance No 20-1202.02
 Expiration Date 01/14/2026
 By: Healy A. Mehn
 Miami Dade Product Control



PROFILE	IMPRESSION
DATE: 1-10-12	
DESIGN: JG	
SCALE: N/A	
DRAWN:	
APPROVED:	
	DATE:

REVISIONS	DATE	DESCRIPTION
1	4-08-12	

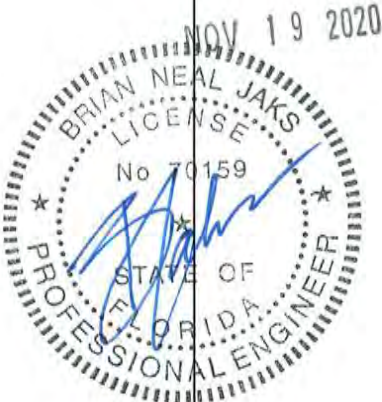



DIM 'A' = 2", 2.5", 3", 4", 5", or 6"

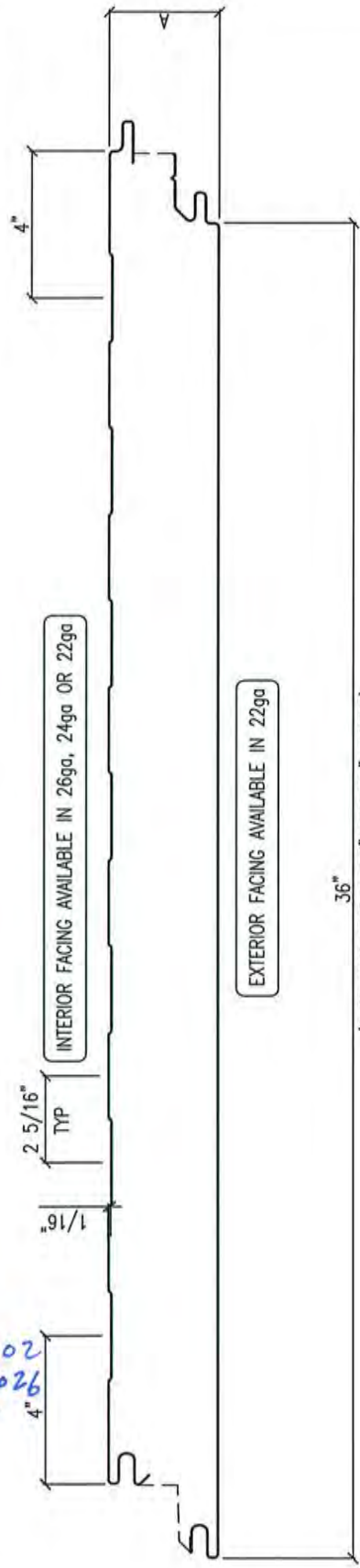

INTERIOR FACING AVAILABLE IN 26ga, 24ga OR 22ga

EXTERIOR FACING AVAILABLE IN 22ga

(ALSO AVAILABLE IN 30" AND 24" WIDTHS)

EXTERIOR FACING IS SMOOTH

PRODUCT REVISED
is complying with the Florida
Building Code
Acceptance No 20-1202.02
Expiration Date 01/14/2026
By Holly A. M...
Miami Dist

INFINITY logo and metadata table

Table with columns: REVISIONS, DATE, DESCRIPTION

PROFILE: INFINITY
DATE: 1-10-12
DRAWN BY:
SCALE: N/A
CHECKED:
APPROVED:
DATE:

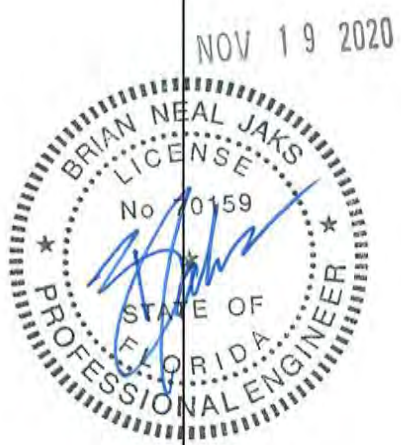



DIM 'K' = 2", 2.5", 3", 4", 5", or 6"

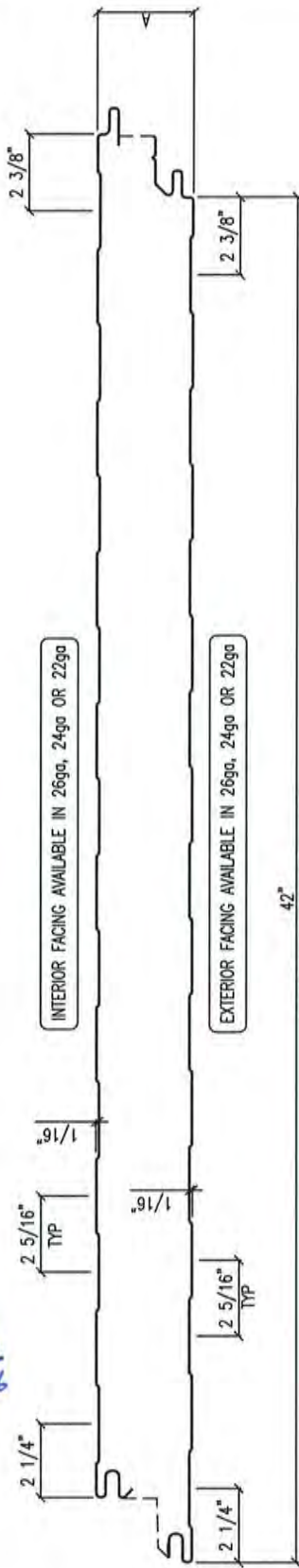

INTERIOR FACING AVAILABLE IN 26ga, 24ga OR 22ga

EXTERIOR FACING AVAILABLE IN 26ga, 24ga OR 22ga

42"
(ALSO AVAILABLE IN 36" WIDTH)

PRODUCT REVISED as complying with the Florida Building Code Acceptance No 20-1202.02 Expiration Date 01/14/2026 By Heidi A. Nelson Miami Dade Product Control



PROFILE:	MESALINE
DATE:	1-10-12
DRAWN BY:	
SCALE:	1/8" = 1'
CHECKED:	
APPROVED:	
DATE:	

REVISIONS	DATE	DESCRIPTION
1	4-18-13	

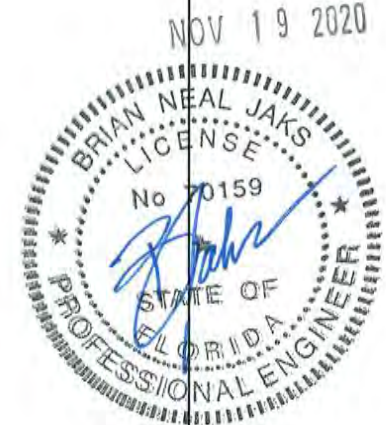



DIM 'A' = 2", 2.5", 3", 4", 5", or 6"

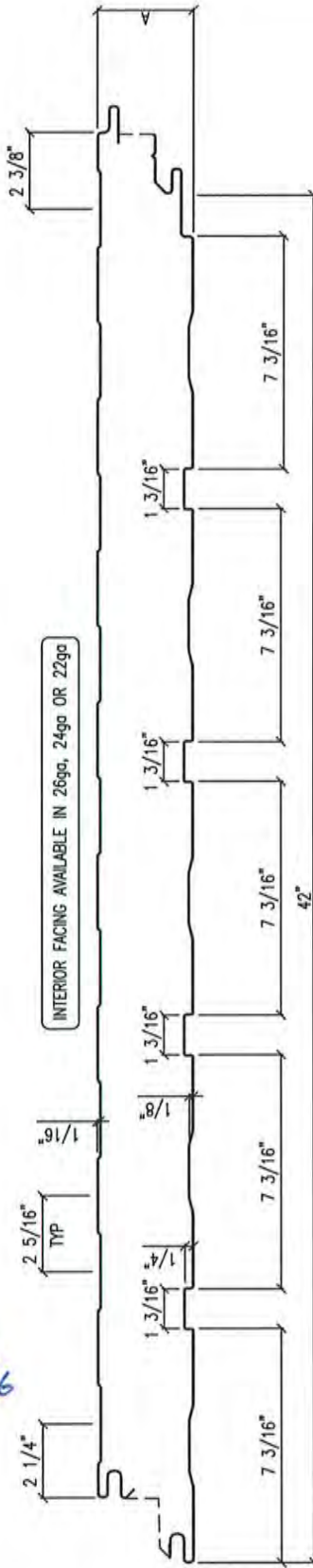

INTERIOR FACING AVAILABLE IN 26ga, 24ga OR 22ga

EXTERIOR FACING AVAILABLE IN 26ga, 24ga OR 22ga

PRODUCT REVISED
 as complying with the Florida
 Building Code
 Acceptance No 20-1202.02
 Expiration Date 01/14/2026
 By H.G.A. Mohr
 Miami Dade Product Control



PROFILE SHADOWLINE

DATE: 1-16-12
 DRAWN BY:
 SCALE: NONE
 CHECKED:
 APPROVED:
 DATE:

REVISIONS	DATE

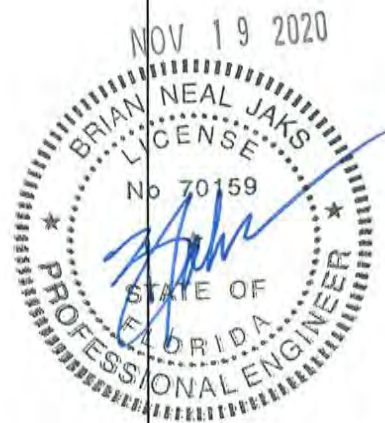



DIM 'A' = 2", 2.5", 3", 4", 5", or 6"

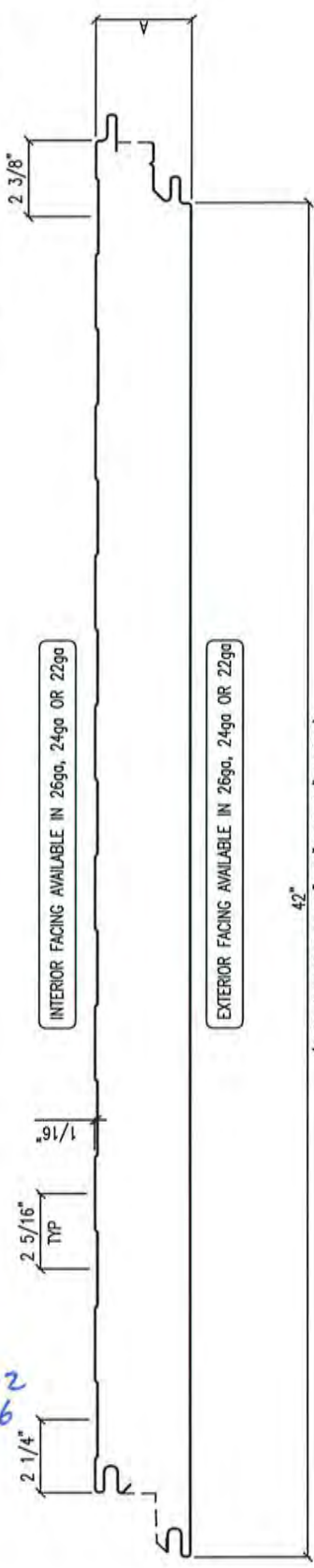

INTERIOR FACING AVAILABLE IN 26ga, 24ga OR 22ga

EXTERIOR FACING AVAILABLE IN 26ga, 24ga OR 22ga

(ALSO AVAILABLE IN 36", 30" AND 24" WIDTHS)

EXTERIOR FACING HAS AN EMBOSSED TEXTURE

PRODUCT REVISED
as complying with the Florida
Building Code
Acceptance No 20-1202.02
Expiration Date 01/14/2026
By Heidi A. Nelson
Miami Dade County



PROFILE:	STUCCO
DATE:	1-10-12
DRAWN BY:	
SCALE:	NONE
CHECKED:	
APPROVED:	
DATE:	

REVISIONS	
NO.	DESCRIPTION
1	
2	
3	
4	
5	
6	
7	
8	
9	
10	





DIM 'A' = 2", 2.5", 3", 4", 5", or 6"

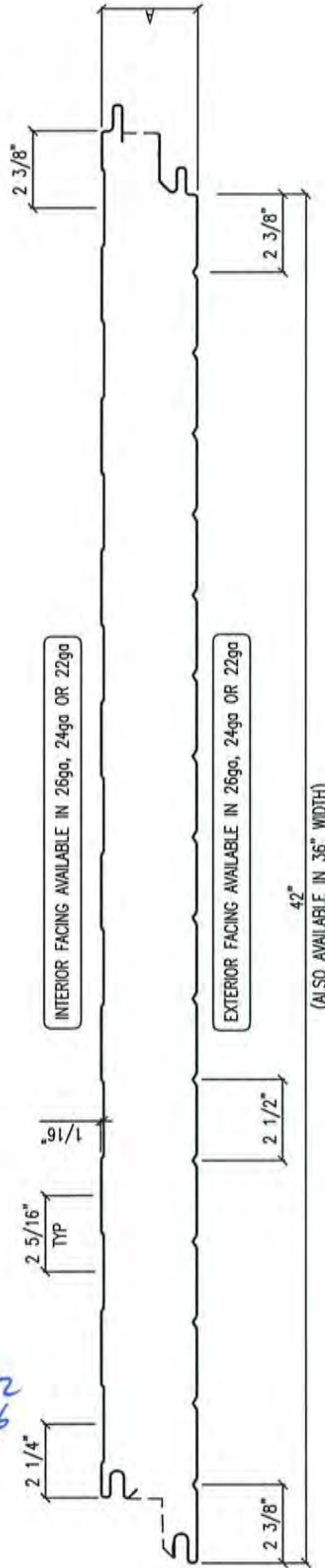

INTERIOR FACING AVAILABLE IN 26ga, 24ga OR 22ga

EXTERIOR FACING AVAILABLE IN 26ga, 24ga OR 22ga

(ALSO AVAILABLE IN 36" WIDTH)

PRODUCT REVISED
 as complying with the Florida
 Building Code
 Acceptance No 20-1202.02
 Expiration Date 01/14/2026
 By H. G. A. Miller
 Miami Dade Product Code



PROFILE:	VEELINE
DATE:	1-10-12
DRAWN BY:	
SCALE:	1:1
CHECKED:	
APPROVED:	
DATE:	

REVISIONS	
NO.	DESCRIPTION
1	4-18-12



Product Name: **WVP Series**
 Manufactured By: **Green-Span Profiles, LP**
 Document Number: **438-0086T-13**
 Prepared By: **Brian N. Jaks, FLPE #70159**



DIM 'A' = 2", 2.5", 3", 4", 5", or 6"

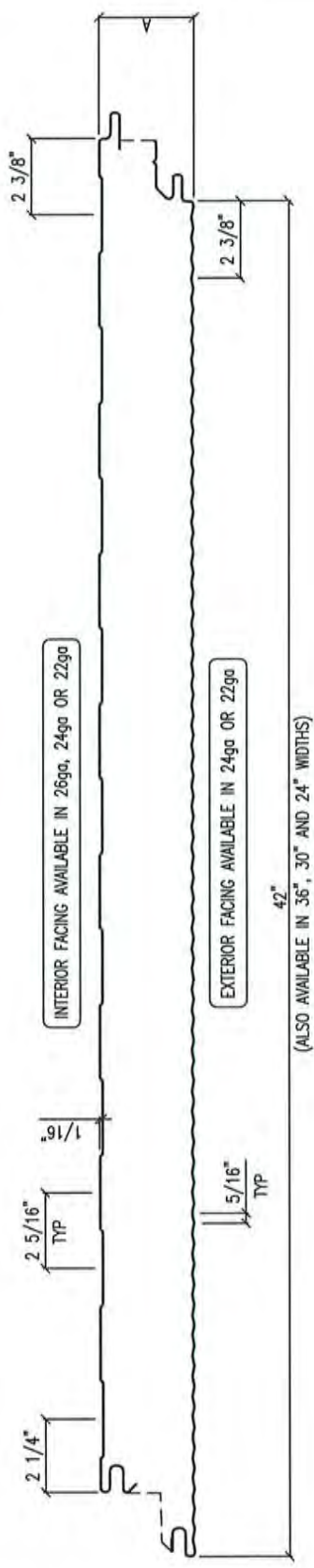

INTERIOR FACING AVAILABLE IN 26ga, 24ga OR 22ga

EXTERIOR FACING AVAILABLE IN 24ga OR 22ga

(ALSO AVAILABLE IN 36", 30" AND 24" WIDTHS)

PRODUCT REVISED
 as complying with the Florida
 Building Code
 Acceptance No 20-1202.02
 Expiration Date 01/14/2026
 By Heidi A. Mahon
 Miami Dade Product Control



PROFILE: **WAVELINE**

DATE: 1-10-12

DRAWN BY:

SCALE: NONE

CHECKED:

APPROVED:

DATE:

NO.	DATE	DESCRIPTION
1	4-10-12	



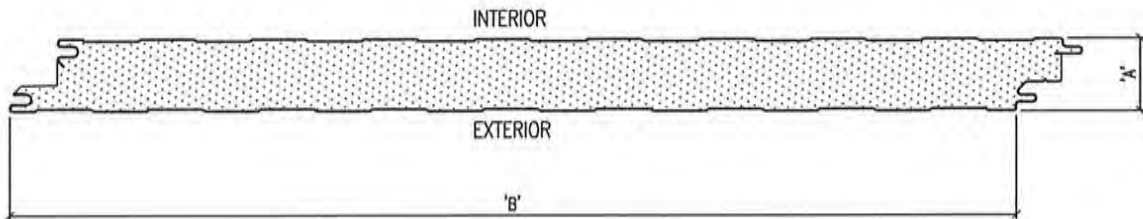

GENERAL PANEL PROFILE
MIN. 26-GA.

DIM 'A' = 2", 2.5", 3", 4", 5", or 6"

DIM 'B' = 42", 36", 30" OR 24"

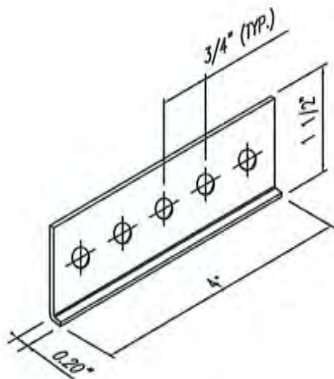

WALL PANEL CLIP [AC-01]
14GA. (0.070") MIN.



1/4-14 X TEK3 SDS FASTENER

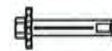

FAB-LOK FASTENER

PRODUCT REVISED
as complying with the Florida
Building Code
Acceptance No 20-1202.02
Expiration Date 01/14/2026
By *Heidi A. Mohr*
Miami Dade Product Control

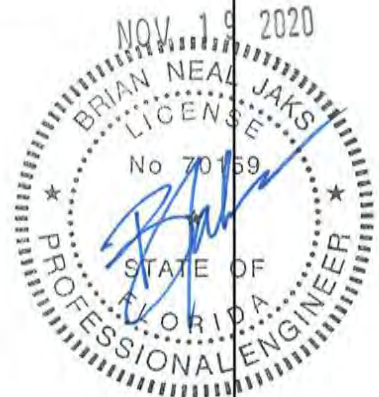

MANUFACTURED BY:



SECTIONS WITH DIMENSIONS AND THICKNESSES

DATE: MARCH 19, 2004	NOTES: CHECK LIST SECTION 'A'
PAGE: 1 OF 3	PRODUCT NAME: IWP SERIES
REVISION: NONE	DOCUMENT NUMBER: 438-0086T-13
	PREPARED BY: BRIAN N. JAKS, FLPE #70159
21200 FM362, WALLER, TEXAS 77484	281-807-7400
	WWW.GREENSPANPROFILES.COM

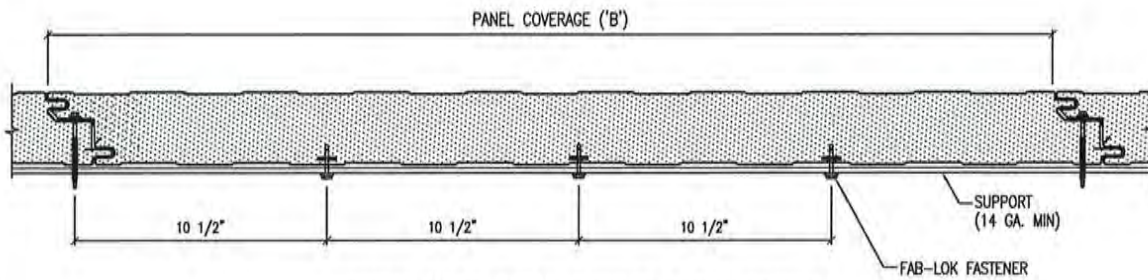

SECTION 'A'-'A': TYPICAL FASTENER PATTERN DIAGRAM

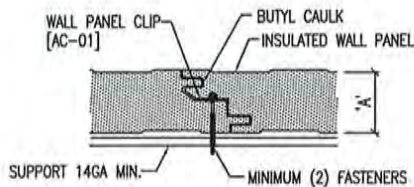

SECTION 'B'-'B': PANEL SIDELAP FASTENING

PRODUCT REVISED
 as complying with the Florida
 Building Code
 Acceptance No 20-1202.02
 Expiration Date 01/14/2026
 By *Heidi A. Nelson*
 Miami Code Product Control

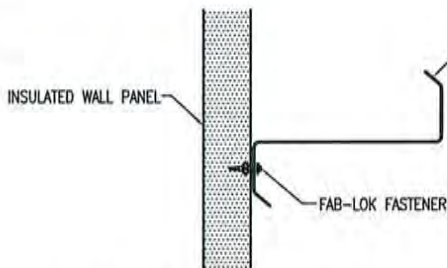
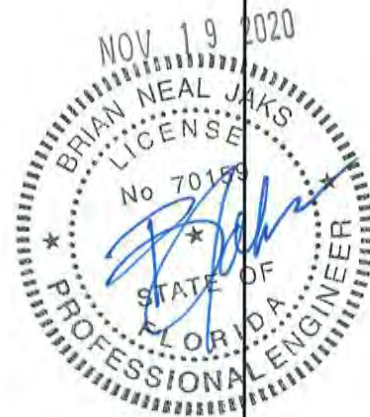

DETAIL 'C': PANEL CONNECTION

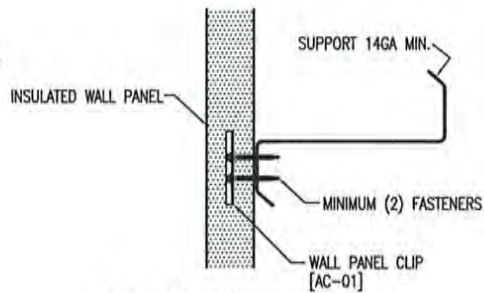

DETAIL 'D': PANEL CONNECTION

MANUFACTURED BY:



ASSEMBLY DETAILS WITH CONNECTIONS		
DATE: MARCH 19, 2004	NOTES: CHECK LIST SECTION 'B'	
PAGE: 2 OF 3	PRODUCT NAME: IWP SERIES	
REVISION: NONE	DOCUMENT NUMBER: 438-0086T-13	
PREPARED BY: BRIAN N. JAKS, FLPE #70159		
21200 FM362, WALLER, TEXAS 77484	281-807-7400	WWW.GREENSPANPROFILES.COM

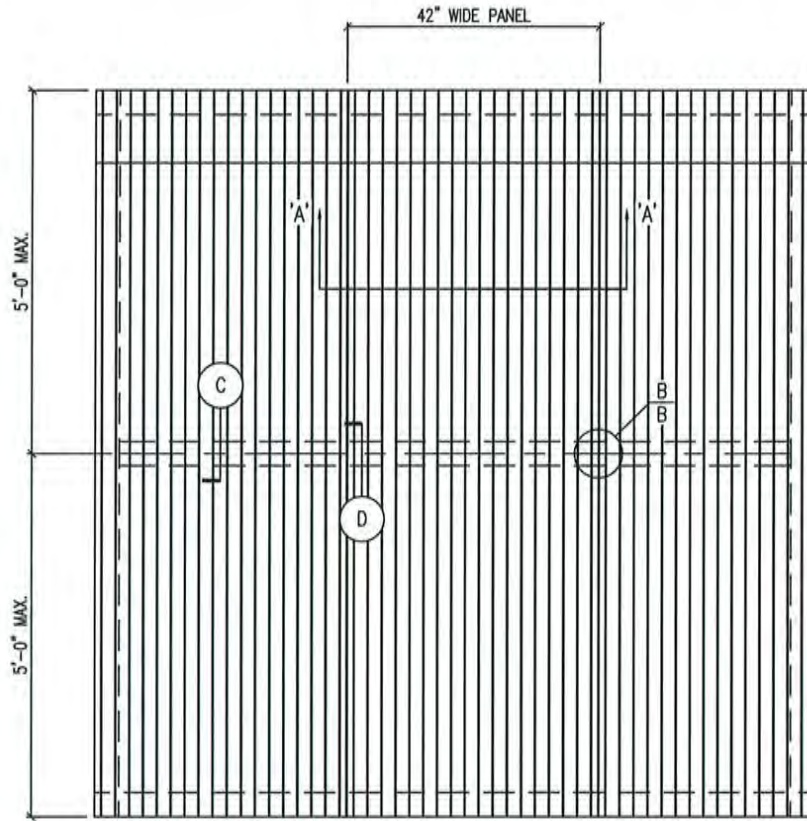

TYPICAL EXTERIOR WALL ELEVATION

PRODUCT REVISED
 as complying with the Florida
 Building Code
 Acceptance No. 20-1202.02
 Expiration Date 01/14/2026
 By: *Hely A. Nelson*
 Miami Dade Product Control



MANUFACTURED BY:



TYPICAL FASTENING DIAGRAMS		
DATE: MARCH 19, 2004	NOTES: CHECK LIST SECTION 'C'	
PAGE: 3 OF 3	PRODUCT NAME: IWP SERIES	
REVISION: NONE	DOCUMENT NUMBER: 438-0086T-13	
PREPARED BY: BRIAN N. JAKS, FLPE #70159		
21200 FM362, WALLER, TEXAS 77484	281-807-7400	WWW.GREENSPANPROFILES.COM